

CoreTech (Type C)

LED Lamp



CORETECH linear
intelligent LED Solutions

LED
TECHNOLOGY



Product Certification

* EMERGENCY BALLAST RESTRICTIONS

Features & Benefits

- Shatterproof Nano Plastic Tube
- NSF2 Rated
- Advanced dimming with Pro-DIM technology: 0-10V and/or AB dimming
- No Polarity: lamp ends can be reversed
- Same wiring as fluorescent lamp/ballast system
- UL 1598C for safety
- High performance Nano Plastic series
- High performance Nano Plastic series
- No Mercury, No UV
- Suitable for Dry and Damp Locations
- Low Temperature Operation
- Instant On
- 50,000 hours with no limitation on On/Off Cycles
- 5-year Warranty
- Evaluated for use in totally enclosed, recessed luminaires, surface mount wall and ceiling luminaires, outdoor luminaires (open surface mount luminaires with compartment protection from weather)
- For use with Class 2 driver only
- Assembled in USA

Specification

Model	Lamp Input Current	System Wattage	Lamp Wattage	Length	CRI	Initial Lumens	Lamp Efficacy (lm/W)	System Efficacy (lm/W)	Beam Angle	CCT
L36T8/850/11P-XT BAA	250mA	12	9	36 in	82	1400	155	117	325	5000K
L36T8/850/11P-XT BAA	300mA	14	11	36 in	82	1600	145	114	325	5000K
L36T8/850/11P-XT BAA	360mA	16	13	36 in	82	1900	146	119	325	5000K

Wiring Diagram



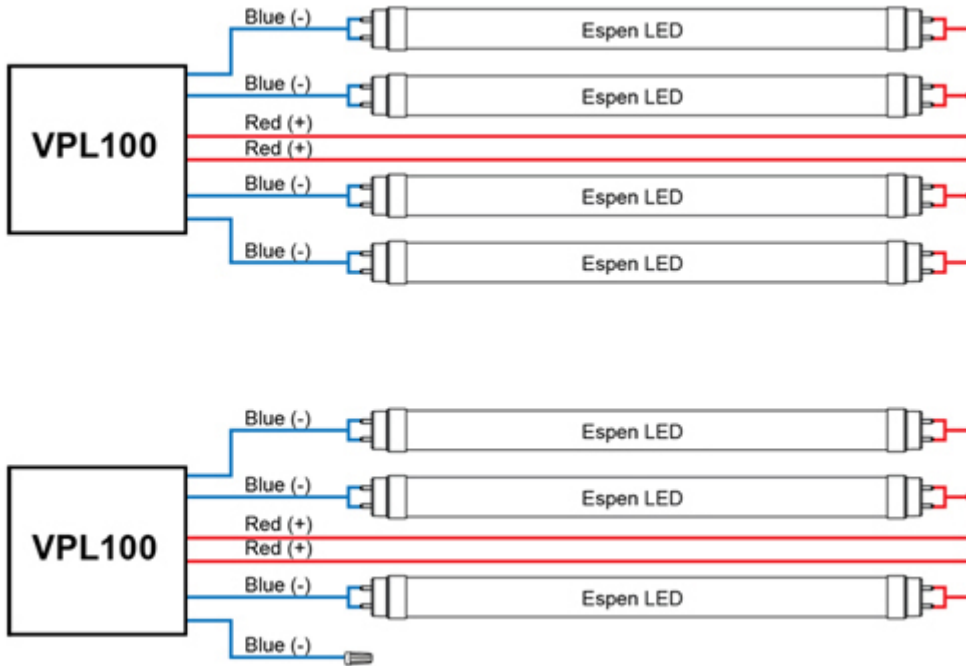

Dlc Information

Order Code	Lamp Input Current	DLC Product ID	DLC Product Model	DLC Version
L36T8/850/11P-XT BAA	250mA	N/A	N/A	N/A
L36T8/850/11P-XT BAA	300mA	N/A	N/A	N/A
L36T8/850/11P-XT BAA	360mA	N/A	N/A	N/A

Specification data is based on tests performed in a controlled environment and represents relative performance. Actual performance can vary depending on operating conditions. Application and performance data subject to change without notice. All specifications are nominal unless noted otherwise.