

CoreTech (Type C)

LED Lamp

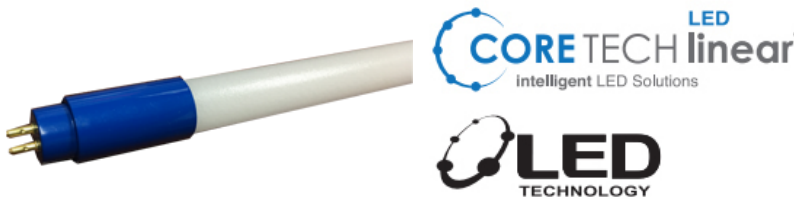

Features & Benefits

- Shatterproof Nano Plastic Tube
- NSF2 Rated
- Advanced dimming with Pro-DIM technology: 0-10V and/or AB dimming
- No Polarity: lamp ends can be reversed
- Same wiring as fluorescent lamp/ballast system
- UL 1598C for safety
- High performance Nano Plastic series
- High performance Nano Plastic series
- No Mercury, No UV
- Suitable for Dry and Damp Locations
- Low Temperature Operation
- Instant On
- 50,000 hours with no limitation on On/Off Cycles
- 5-year Warranty
- Evaluated for use in totally enclosed, recessed luminaires, surface mount wall and ceiling luminaires, outdoor luminaires (open surface mount luminaires with compartment protection from weather)
- For use with Class 2 driver only
- Assembled in USA

Product Certification

* EMERGENCY BALLAST RESTRICTIONS



Specification

Model	Lamp Input Current	System Wattage	Lamp Wattage	Length	CRI	Initial Lumens	Lamp Efficacy (lm/W)	System Efficacy (lm/W)	Beam Angle	CCT
L24T5/835/11P-XT BAA	250mA	11	8	24 in	82	1200	150	109	240	3500K
L24T5/835/11P-XT BAA	360mA	12	9	24 in	82	1300	144	108	240	3500K
L24T5/835/11P-XT BAA	500mA	15	12	24 in	82	1700	141	113	240	3500K

Wiring Diagram



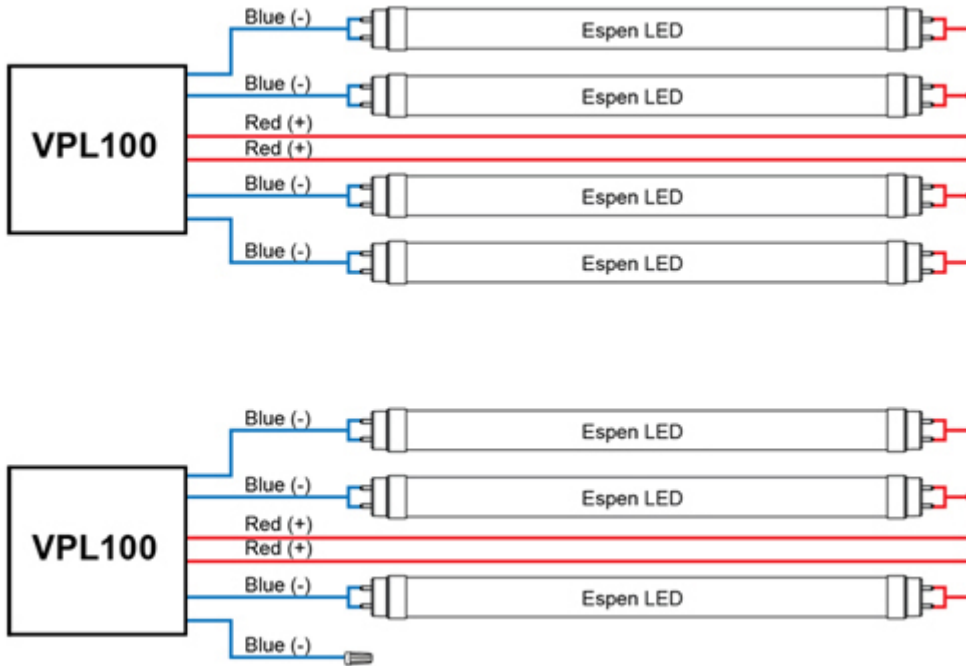

Dlc Information

Order Code	Lamp Input Current	DLC Product ID	DLC Product Model	DLC Version
L24T5/835/11P-XT BAA	250mA	N/A	N/A	N/A
L24T5/835/11P-XT BAA	360mA	N/A	N/A	N/A
L24T5/835/11P-XT BAA	500mA	N/A	N/A	N/A

Specification data is based on tests performed in a controlled environment and represents relative performance. Actual performance can vary depending on operating conditions. Application and performance data subject to change without notice. All specifications are nominal unless noted otherwise.